

TWISTED PAIR INPUTS FOR TUBES

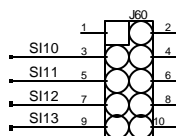

BAY 1

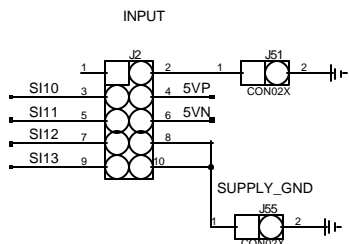

OUTPUT

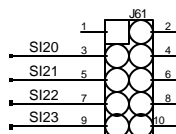
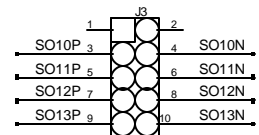

BAY 2

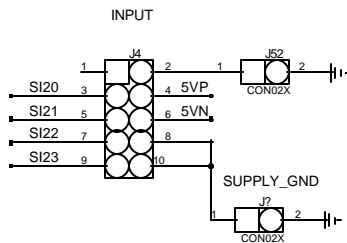

OUTPUT

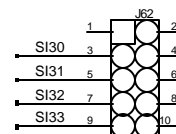
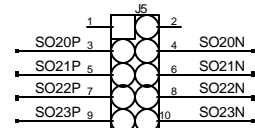

BAY 3

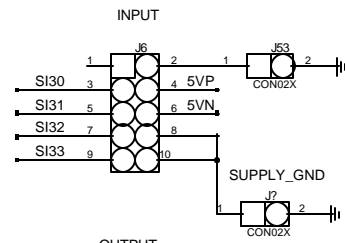

OUTPUT

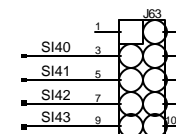
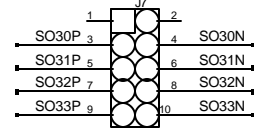

BAY 4

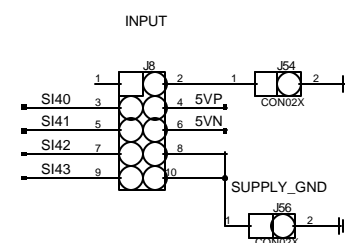

OUTPUT

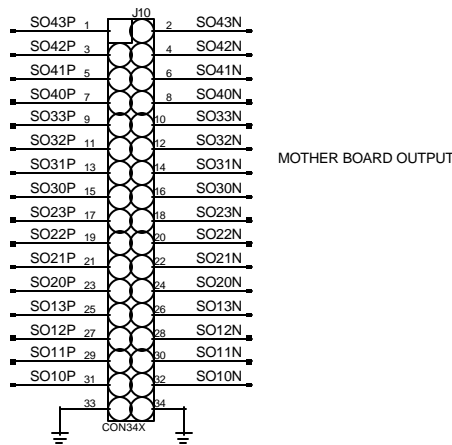
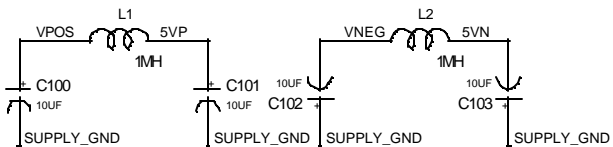
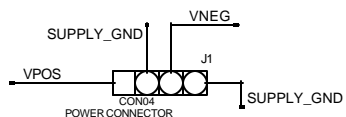
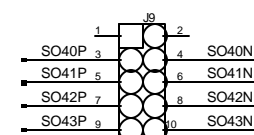

MOTHER BOARD OUTPUT

THE OHIO STATE UNIVERSITY PHYSICS DEPARTMENT ELECTRONICS LAB 174 WEST 18TH AVE, COLUMBUS OH 43210			
MOTHER BOARD			
PARENT PAGE	PROJECT	D776o	
BY RTK	DATE 8-13-2003_10:11	FILE	MOBO. PAGE 1